

# BIOTIX COBRA PIPETTE

USER'S  
GUIDE

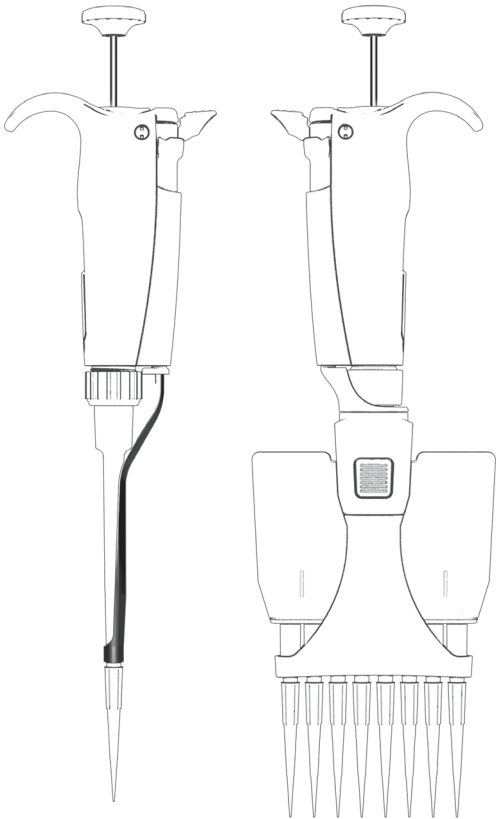

**Biotix**  
Fluid Innovation

# BIOTIX COBRA PIPETTE

Contents	Page
1- INTRODUCTION	3
2- PARTS CHECK LIST	3
3- DESCRIPTION	4
4- SETTING THE VOLUME	6
5- USER ADJUSTMENT	7
6- PIPETTING	8
7- GENERAL GUIDELINES FOR GOOD PIPETTING	10
8- ACCESSORIES	12
9- GLP FEATURES	12
10- TROUBLESHOOTING	13
11- LEAK TEST	14
12- MAINTENANCE	15
13- CLEANING AND STERILIZATION	20
14- SPECIFICATIONS	24
15- SPARE PARTS	25
MAINTENANCE & CALIBRATION	30
WARRANTY	31

## 1 - INTRODUCTION

The BIOTIX Cobra pipette is an air displacement mechanism and is used with disposable pipette tips.

This pipette line provides:

- Light and comfortable body, for both right and left handed users.
- Low pipetting forces ensuring ergonomics and users' well-being.
- Controlled volume setting.

Eight single channel models cover a volume range from 0.2  $\mu$ L to 10 mL.

Eight multichannel models (4 x 8-ch and 4 x 12-ch) cover a volume range from 0.5  $\mu$ L to 300  $\mu$ L.

## 2 - PARTS CHECK LIST

Just take a moment to verify that the following items are present:

### Single models

- Biotix Cobra Pipette,
- User's Guide,
- Certificate of conformity,
- Calibration Key.

### Multichannel models

- Biotix Cobra Pipette,
- User's Guide,
- Ejector spacer for short collar tips,
- Certificate of conformity,
- Calibration key.

# BIOTIX COBRA PIPETTE

## 3 - DESCRIPTION

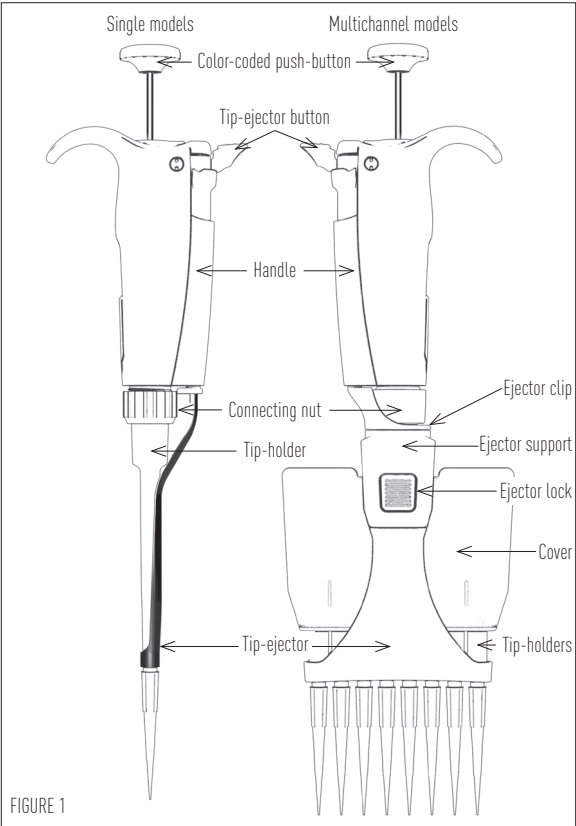

FIGURE 1

**For the BTX-2 and BTX-10 models**, a dual position adapter (plastic) is required to eject short tip collar or long tip collar. BTX-2 and BTX-10 models are delivered with the adapter in place, ready to use for Biotix tips.

If long collar tips are used, the adapter must be repositioned in the longer slot as follows:

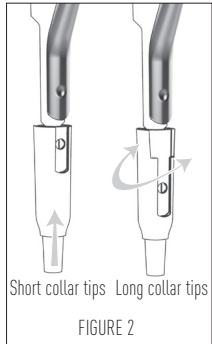

FIGURE 2

- 1 Pull the adapter down from the metallic road.
- 2 Turn the adapter through 180°.
- 3 Refit the adapter so that the end of the metallic rod engages the shorter slot of the adapter.

To fit this tip ejector extension, push the extension firmly onto the end of the clip ejector until it clicks into place. To remove it, gentle twist and pull the extension. If a new adapter is required, you can order it (see chapter 15 - Spare parts).

### Ejector spacer for Multichannel models

Multichannel models fit with long collar tips. If you use short collar tips, you might have to insert the ejector spacer especially indicated for that:

- Remove the tip-ejector, keep both ejector locks depressed; pull the tip-ejector down.
- Insert the broad ejector spacer and click it to the tip-ejector.
- To refit the tip-ejector, gently re-insert the tip-ejector vertically into the rails of the ejector support.

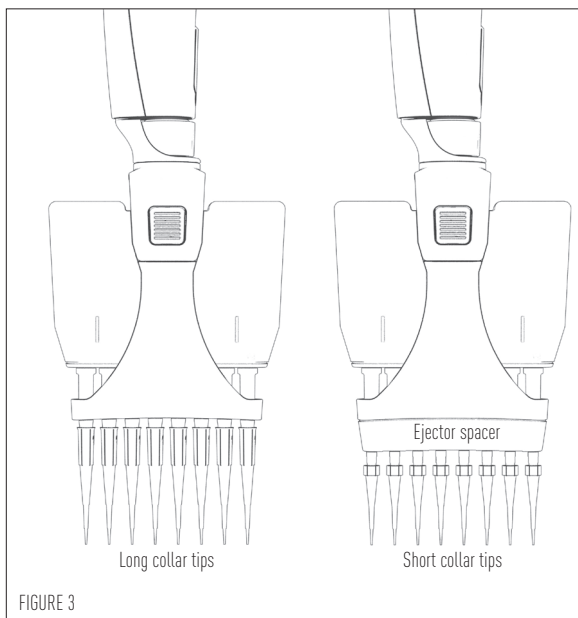

FIGURE 3

# BIOTIX COBRA PIPETTE

## 4 - SETTING THE VOLUME

The volume of liquid to be aspirated is set using the volumeter. The digits are colored either black or green to indicate the position of the decimal point, depending on the model (see examples).

BTX-2 1 2 5 1.25 $\mu$ L	BTX-10 0 7 5 7.5 $\mu$ L	BTX-20 1 2 5 12.5 $\mu$ L	BTX-100 0 7 5 75 $\mu$ L	BTX-X10 0 7 5 7.5 $\mu$ L	BTX-X20 1 2 5 12.5 $\mu$ L
BTX-200 1 2 5 125 $\mu$ L	BTX-1000 0 7 5 0.75 mL	BTX-5000 1 2 5 1.25 mL	BTX-10mL 0 7 5 7.5 mL	BTX-X200 1 2 5 125 $\mu$ L	BTX-X300 1 2 5 125 $\mu$ L



MODEL	Color of volumeter digits		
	Black	Green	Increment
BTX-2	$\mu$ L	0.01 $\mu$ L	0.002 $\mu$ L
BTX-10 to BTX-20	$\mu$ L	0.1 $\mu$ L	0.02 $\mu$ L
BTX-8X-10, BTX-8X-20	$\mu$ L	0.1 $\mu$ L	0.02 $\mu$ L
BTX-12X-10, BTX-12X-20			
BTX-100, BTX-200, BTX-8X-200, BTX-12X-200	$\mu$ L	-	0.2 $\mu$ L
BTX-8X-300, BTX-12X-300	$\mu$ L	-	0.2 $\mu$ L
BTX-1000	0.01 mL	mL	0.002 mL
BTX-5000	0.01 mL	mL	0.002 mL
BTX-10 mL	mL	0.1 mL	0.02 mL

The volume is set by turning the push-button (see figure 4). To obtain maximum accuracy when setting the volume, proceed as follows:

→ when **decreasing** the volume setting, slowly reach the required setting, making sure not to overshoot the mark.

→ when **increasing** the volume setting, pass the required value by 1/3 of a turn and then slowly decrease to reach the volume, making sure not to overshoot the mark.

## 5 - USER ADJUSTMENT

The calibration of the Biotix Cobra Pipettes has been performed with distilled water and very high precision volumetric instruments. Adjusting the pipette can be necessary for different solutions due to their density, viscosity, surface tension and/or vapor pressure etc. Calibration is sometimes recommended when it is used in high altitudes or with special tips. It can also be recalibrated when other pipette tips are used.

To adjust the volume setting:

- 1 Remove the push button.
- 2 Use the calibration key to take off the block cover.
  - a. Insert the metal rod into the calibration tool on the hexagonal side.
  - b. Engage the two rectangular hooks of part 2 into the two holes of the block cover. You should feel them clipped on firmly in the hidden part of the pipette (see figure 5).
  - c. Make sure to hold the part 1 at the top cap, along the part 2.
  - d. Turn the part 2 counterclockwise slowly to remove the block cover (see figure 6).  
Put the block cover apart.
- 3 Use the calibration key to adjust the pipette
  - a. Insert the metal rod into the calibration key on the circle tip side (see figure 7). Lock it into place. You should feel the internal part of the calibration key clamped and clipped on firmly. If it is not the case, turn it counterclockwise slowly. Then, turn the plastic connecting nut of the part 1 slowly until it's locked in place (see figure 8).

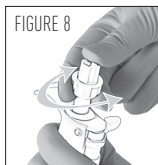
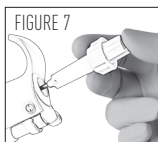
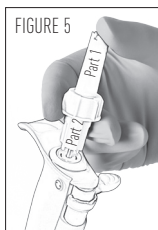

# BIOTIX COBRA PIPETTE

b. Hold the connecting nut of the part 1 with one hand and turn the part 2 with the other one according to the correction needed (see figure 9).

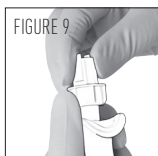

4 Once the desired volume is set, remove the calibration key and put back the block cover using the hexagonal side. Turn it clockwise to lock to block cover. Put back the push button.

With reference water, one revolution (1/8 turn of the calibration tool) of the volume setting corresponds to:

Volume range	Vol. per 1/8 turn (equivalence in $\mu\text{L}$ )
BTX-2	0.012 i.e: 1 full turn is 0.096
BTX-10	0.047
BTX-20	0.120
BTX-100	0.48
BTX-200	1.20
BTX-1000	4.75
BTX-5000	23.8
BTX-10ML	48
BTX-8X-10	0.058
BTX-12X-10	
BTX-8X-20	0.120
BTX-12X-20	
BTX-8X-200	1.20
BTX-12X-200	
BTX-8X-300	1.90
BTX-12X-300	

## 6 - PIPETTING

### Fitting the tips

Biotix Cobra pipettes have been designed to fit Biotix tips. This combination provides an optimum seal and low ejection forces.

### Pre-rinse the tips

Some liquids (e.g. protein-containing solutions and organic solvents) can leave a film of liquid on the inside wall of the tip; pre-rinse the tip to minimize any errors that may be related to this phenomenon.

Pre-rinsing consists of aspirating the first volume of liquid and then dispensing it to waste. Tips will not fall off nor will they have to be manually positioned.



Make sure first that the pipette is calibrated with the tips that you are using. Then, subsequent volumes that you pipette will have levels of accuracy and precision within specifications. Using other tips may require a validation of the pipetting system.

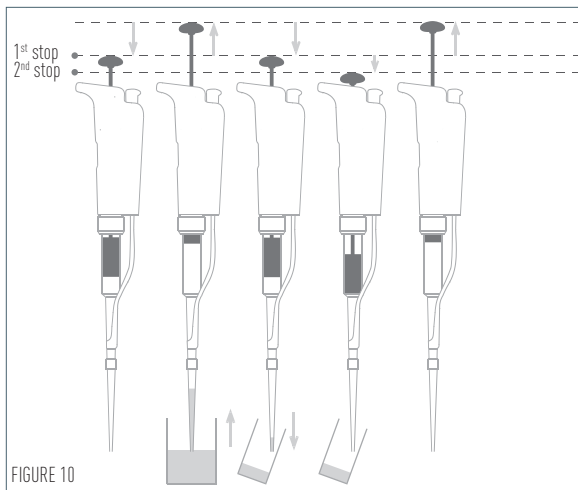

FIGURE 10

## Aspirate

- 1 Press the push-button to the **first stop** (this corresponds to the set volume of liquid).
- 2 Hold the pipette vertically and immerse the tip in the liquid (see immersion depth table, page 11). Release the push-button slowly and smoothly (to top position) to aspirate the set volume of liquid. Wait one second (time depends on model, see table page 11); then withdraw the pipette tip from the liquid. You may wipe any drop lets away from the outside of the tip using a medical wipe, however if you do so take care to avoid touching the tip's orifice.

☞ *For the multichannel models, use a reagent reservoir.*

## Dispense

- 1 Place the end of the tip against the inside wall of the recipient vessel (at an angle of 10° to 40°).

# BIOTIX COBRA PIPETTE

- 2 Press the push-button slowly and smoothly to the **first stop**.
- 3 Wait for at least a second, then press the push-button to the **second stop** to expel any residual liquid from the tip.  
Keep the push-button pressed fully down and (while removing the pipette) draw the tip along the inside surface of the vessel.
- 4 Release the push-button, smoothly. Eject the tip by pressing firmly on the tip-ejector button.

 For the multichannel models, use a reagent reservoir.

## Ejecting the tip

Before you start to pipetting, you can adjust the tip-ejector button according to your preferences.

- 1 Position the tip-ejector button. Simply rotate the tip-ejector button to the most comfortable position: left, right or middle.

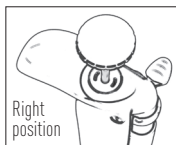
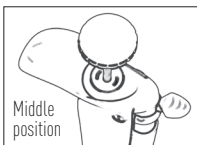
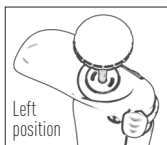
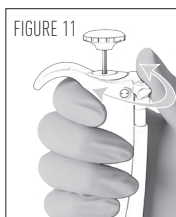

- 2 Activate the tip-ejector. You can either push the tip-ejector button with the tip of the thumb as usual, or with the base of your thumb for more comfort. Please note the BTX-5000 and BTX-10mL are not equipped with a tip-ejector.

## 7 - GENERAL GUIDELINES FOR GOOD PIPETTING

- 1 Make sure that you operate the push-button slowly and smoothly.

- 2 When aspirating, keep the tip at a constant depth below the surface of the liquid (refer to the table).
- 3 Change the tip before aspirating a different liquid, sample, or reagent.
- 4 Change the tip if a droplet remains at the end of the tip from the previous pipetting operation.

Table Immersion Depth and Wait Time

Model	Immersion Depth (mm)	Wait Time (second)
BTX-2	1	1
BTX-10	1	1
BTX-20	2-3	1
BTX-100	2-4	1
BTX-200	2-4	1
BTX-1000	2-4	2-3
BTX-5000	3-6	4-5
BTX-10mL	5-7	4-5
BTX-8X-10, BTX-12X-10	1	1
BTX-8X-20, BTX-12X-20	2-3	1
BTX-8X-200, BTX-12X-200	2-3	1
BTX-8X-300, BTX-12X-300	2-4	1

- 5 Each new tip should be pre-rinsed with the liquid to be pipetted.
- 6 Liquid should **never** enter the tip-holder; to prevent this:
  - press and release the push-button slowly and smoothly,
  - never turn the pipette upside down,
  - never lay the pipette on its side when there is liquid in the tip.
- 7 If you use the same tip with a higher volume, pre-rinse the tip.
- 8 For volatile solvents you should saturate the air-cushion of your pipette by aspirating and dispensing the solvent repeatedly before aspirating the sample.
- 9 When the pipetted liquid is not at room temperature, pre-rinse the tip several times before use.
- 10 You may remove the tip-ejector (see chapter 12 - Maintenance) to aspirate from very narrow tubes.
- 11 After pipetting acids or other corrosive liquids that emit vapors, remove the tip-ejector, the tip-holder, rinse, dry and lubricate the piston (see chapter 12 - Maintenance).

# BIOTIX COBRA PIPETTE

- 12 Do not pipette liquids having temperatures above 70°C or below 4°C. The pipette can be used between +4°C and +40°C but the specifications may vary according to the temperature (refer to the ISO8655-2 standard for conditions of use).

⇒ *Pipettes should be held in the vertical position.*

## 8 - ACCESSORIES

To make pipetting more comfortable and more secure, several accessories are available:

To avoid the possibility of liquid running back into the pipette, store the pipette vertically.

To identify or personalize your pipette, identification clips are available.

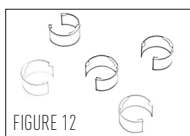

BTX carousel stand (7 pipettes)	BTX-CAR
Identification clips (mixed colors set of 10)	FE07060
Identification clips (red, set of 10)	FE07061
Identification clips (yellow, set of 10)	FE07062
Identification clips (green, set of 10)	FE07063
Identification clips (blue, set of 10)	FE07064
Identification clips (white, set of 10)	FE07065

## 9- GLP FEATURES

The Serial Number is engraved on the body of the pipette. It provides a unique identification of the pipette and the manufacturing date. Example: 15A1425

To know the specific details about your pipette, see the table.

Year /CODE	Month/CODE	NUMBER (example)
2015/15	January/A	0001
2016/16	February/B	0325
2017/17	March/C	0500
2018/18	April/D	0750
2019/19	May/E	1000
2020/20	June/G	1300
2021/21	July/H	1600
2022/22	August/J	2000
2023/23	September/K	2400
2024/24	October/L	2600
2025/25	November/M	2800
2026/26	December/N	3000

The Bar Code on the box and the certificate of conformity provide traceability of your pipette.

## 10 - TROUBLESHOOTING

A quick inspection of the pipette may help you to detect a problem.

The following tables may help you to identify and correct the problem you might encounter.

For any other symptom or if you can't solve the problem, please contact your supplier.

### For single models

Symptom	Possible Cause	Action
Pipette is leaking sample	Damaged tip-holder Worn O-ring or seal	Replace the tip-holder Replace both parts and lubricate
Pipette won't aspirate	Worn O-ring Damaged tip-holder Connecting nut is loose Damaged or corroded piston Improper repair or assembly	Replace both parts and lubricate Replace the tip-holder Tighten connecting nut Return pipette to supplier See Chapter 12 - Maintenance
Pipette is inaccurate	Improper repair or assembly Unscrewed tip-holder Connecting nut is loose	See Chapter 12 - Maintenance Tighten connecting nut Tighten connecting nut
Pipette is not precise	Tip-holder is loose Connecting nut is loose Incorrect operator technique Damaged or corroded piston(s) Damaged tip-holder(s) Worn O-ring or seal	Tighten connecting nut Tighten connecting nut Operator training Return pipette to supplier Replace the tip-holder Replace both parts and lubricate
Tips fall off or do not fit correctly	Low quality tips Dirty tip-holder Damaged tip-holder(s) Damaged tip-ejector The tip-ejector is loose The ejector lock is misaligned	Use Biotix tips to have optimum results of the pipetting system Clean the tip-holder with isopropanol or ethanol Replace the tip-holder Replace tip-ejector Assemble the tip-ejector properly Align the ejector lock
Pipetting seize up	Piston need lubricant	Lubricate piston assembly

# BIOTIX COBRA PIPETTE

## For Multichannel models

Symptom	Possible Cause	Action
Tips fall off or do not fit correctly	Low quality tips	Use Biotix tips to have optimum results of the pipetting system
	Tip-ejector damaged	Replace tip-ejector
	Ejector spacer damaged	Replace ejector spacer
	Dirty tip-holder	Clean them with ethanol or isopropanol
	Damaged tip-holder	Contact your local supplier
Pipette won't aspirate	Connecting nut is loose	Tighten connecting nut
Pipette is inaccurate	Connecting nut is loose	Tighten connecting nut
Pipette is not precise	Connecting nut is loose	Tighten connecting nut
	Incorrect operator technique	Operator training

## 11 - LEAK TEST

This test may be performed at any time to check that the pipette does not leak, especially after performing a maintenance or sterilization procedure. If a pipette fails this test, replace the O-ring and seal. After making sure that the pipette is correctly reassembled, repeat this test.



### For the BTX-2 to BTX-200 single channel models:

- 1 Fit with Biotix Pipette Tips.
- 2 Set the pipette to the maximum volume given in the specifications, and pre-rinse.
- 3 Aspirate the set volume from a beaker of distilled water.
- 4 Maintain the pipette in the vertical position and wait for 20 seconds.
- 5 If a water droplet appears at the end of the tip there is a leak.
- 6 If you see no droplet, re-immers the tip below the surface of water.

- 7 The water level inside the tip should remain constant; if the level goes down there is a leak.

### **For the BTX-1000, BTX-5000 and BTX-10mL single channel models:**

- 1 Fit with Biotix Pipette Tips.
- 2 Set the pipette to the maximum volume given in the specifications.
- 3 Aspirate the set volume from a beaker of distilled water.
- 4 Maintain the pipette in the vertical position and wait for 20 seconds.
- 5 If a water droplet appears at the end of the tip, there is a leak.

### **For the Multichannel models (8X - 12X):**

- 1 Fit Biotix Pipette tips.
- 2 Set the pipette to the maximum volume given in the specifications, and pre-rinse.
- 3 Aspirate the set volume from a reagent reservoir of distilled water.
- 4 Maintain the pipette in the vertical position and wait for 20 seconds; fluid level in tips should remain constant.
- 5 If a water droplet appears at the end of the tip, there is a leak.
- 6 If you see no droplet, for volumes below 200  $\mu\text{L}$ , re-immerses the tip below the surface of water.
- 7 The water level inside the tip should remain constant; if the level goes down there is a leak.

## **12A - MAINTENANCE FOR THE SINGLE CHANNEL MODELS ONLY**

Routine maintenance will help to keep your pipette in good condition, ensuring a continued high level of performance.

# BIOTIX COBRA PIPETTE

Maintenance is limited to:

- Cleaning or sterilization (see Chapter 13 - Cleaning and Sterilization).
- Replacing spare parts.
- Greasing the piston assembly.

*Lubricant tube 1 g is available under the reference FE07066.*

**BTX-2 and BTX-10 should not be disassembled**, so you may only replace the push-button, tip-ejector, dual position tip-ejector and its adapter. With these pipettes if the tip-holder is damaged, the piston may also be damaged.

## Changing the tip-ejector

### To remove

- 1 Push the ejection button.
- 2 Push laterally the tip-ejector.
- 3 Slide and remove the tip-ejector.

### To refit

- 1 Push the ejection button.
- 2 Slide the tip-ejector along the tip-holder.
- 3 Clip the tip-ejector on the body of the pipette.

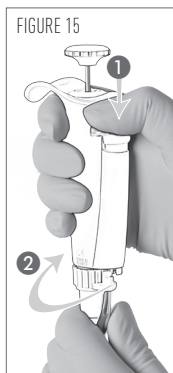

## Changing the tip-holder – no tools required

- 1 Remove the tip-ejector (see above).
- 2 Unscrew the connecting nut by turning it clockwise.
- 3 Carefully separate the lower and upper parts.
- 4 Remove the piston assembly and the seals.
- 5 Clean, sterilize, or replace the tip-holder.
- 6 If necessary, lubricate lightly the piston and its seals (see below).
- 7 Reassemble the pipette (refer to the figure 16).
- 8 Tighten the connecting nut (turn counterclockwise).
- 9 Refit the tip-ejector (see above).



## Servicing the piston assembly

You may remove the piston assembly for cleaning purposes only. If the piston assembly is changed, the pipette must be adjusted and calibrated in the Supplier Service Center. As the models BTX-2 and BTX-10 contain miniaturized parts, it is best not to disassemble these pipettes yourself.

- 1 Remove the tip-ejector (see above).
- 2 Unscrew the connecting nut by turning it clockwise.
- 3 Carefully separate the lower and upper parts.
- 4 Remove the piston assembly, O-ring and seal.
- 5 Leave exposed the piston, clean it with isopropanol or ethanol and lubricate lightly.

**For BTX-20, BTX-100, BTX-200:** lubricate only the useful part of the piston (20 ±5 mm length) and the O-ring.

**For BTX-1000:** lubricate the piston.

**For BTX-5000, BTX-10mL:** disassemble the seals, lubricate their internal part and lubricate the piston. Do not lubricate the O-ring.

- 6 Reassemble the pipette (refer to the figure 16).
- 7 Tighten the connecting nut (turn counterclockwise).
- 8 Refit the tip-ejector (see above).

## Changing the seals

The O-ring and seal are on the piston; if worn or damaged in any way (chemical or mechanical), they must be replaced. As the models BTX-2 and BTX-10 contain miniaturized parts, it is best not to disassemble these pipettes yourself, please contact your Supplier Service Center.

The dimensions of the O-ring vary depending on the model of pipette.

- 1 Remove the tip-ejector (see above).
- 2 Unscrew the connecting nut by turning it clockwise.
- 3 Carefully separate the lower and upper parts.
- 4 Remove the piston assembly, O-ring and seal.

# BIOTIX COBRA PIPETTE

FIGURE 16

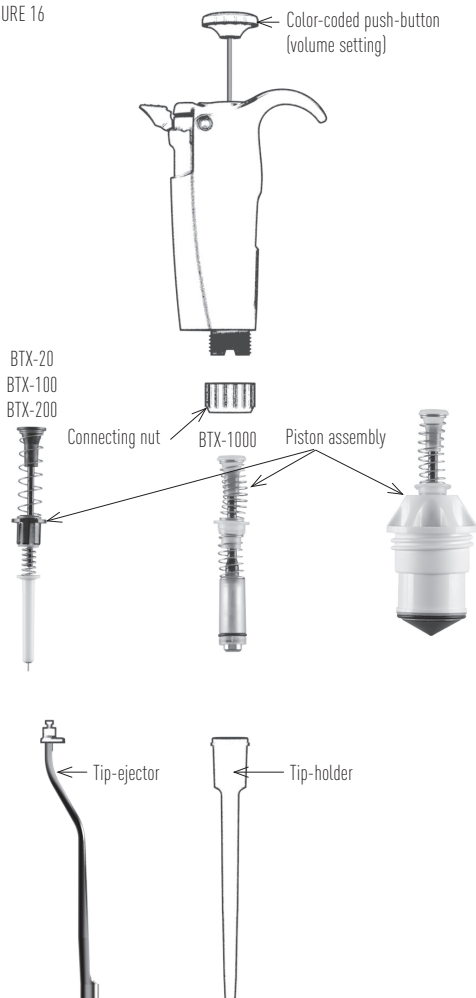

- 5 If necessary clean the piston and replace the seal ; lubricate them lightly. Please place them in the correct order.
- 6 Reassemble the pipette (refer to the figure 16).
- 7 Tighten the connecting nut (turn counter-clockwise).
- 8 Refit the tip-ejector (see above).

## 12B - MAINTENANCE FOR THE MULTI-CHANNEL MODELS ONLY

Routine maintenance will help keep your pipette in good condition, ensuring a continued high level of performance.

Maintenance is limited to:

- Cleaning or sterilization (see Chapter 13 - Cleaning and Sterilization)
- Replacing spare parts
- Greasing the piston assembly.

FIGURE 17

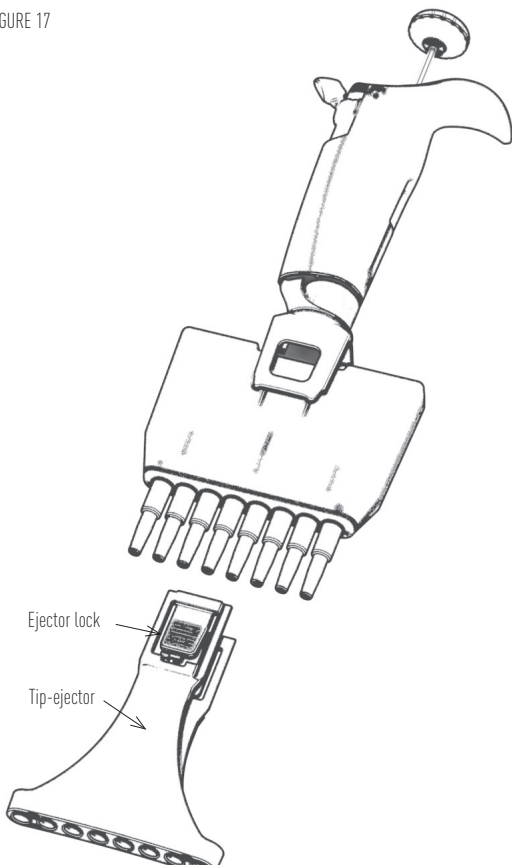

# BIOTIX COBRA PIPETTE

## Changing the tip-ejector

To remove the tip-ejector, keep both ejector locks depressed. Pull the tip-ejector down. To refit the tip-ejector, gently re-insert the tip-ejector vertically into the rails of the ejector support. Pull lightly on the tip-ejector to check the position.

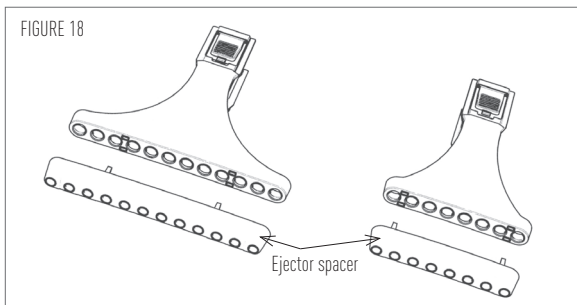

## 13 - CLEANING AND STERILIZATION

Biotix Cobra Pipettes are designed so that the parts normally in contact with liquid contaminants, can easily be cleaned and decontaminated. However, because the models BTX-2 and BTX-10 contain miniaturized parts, it is best not to disassemble these pipettes yourself; please contact your Supplier Service Center.

Liquid must never enter the upper part (handle) of any pipette.

### Cleaning for the Single Models only

The pipette must be cleaned, as described below, before it is decontaminated. Soap solution is recommended for cleaning these models.

#### *External cleaning*

- 1 Remove the tip-ejector.
- 2 Wipe the tip-ejector with a soft-cloth or lint-free tissue impregnated with soap solution.

- ③ Wipe the entire pipette with a soft-cloth or lint-free tissue impregnated with soap solution, to remove all dirty marks. If the pipette is very dirty, a brush with soft plastic bristles may be used.
- ④ Wipe the entire pipette and the tip-ejector with a soft cloth or lint-free tissue soaked with distilled water.
- ⑤ Refit the tip-ejector and allow the pipette to dry.

### **Internal cleaning**

The following components only can be immersed in a cleaning solution: connecting nut, tip-ejector, tip-holder, piston assembly, seal and O-ring.

- ① Disassemble the pipette as described in the chapter 12A - Maintenance.
- ② Set aside the upper part in a clean, dry place.
- ③ Clean the individual components of the lower part of the pipette using an ultrasonic bath (20 minutes at 50°C) or with a soft-cloth and brushes. Note that the piston assembly and seals must be degreased with isopropanol or ethanol before being immersed in another ultrasonic bath. Small round brushes with soft plastic bristles may be used to clean the interior of the tip-holder.
- ④ Rinse the individual components with distilled water.
- ⑤ Leave the parts to dry by evaporation or wipe them with a clean soft-cloth or lint-free tissue.
- ⑥ Reassemble the pipette as described in the chapter 12A - Maintenance.

### **Cleaning for the Multichannel Models only**

The pipette must be cleaned, as described below, before it is decontaminated. Soap solution is recommended for cleaning these models.

The following components **only** can be immersed in a cleaning solution: tip-ejector and ejector spacer.

- ① Remove the tip-ejector and the ejector spacer.

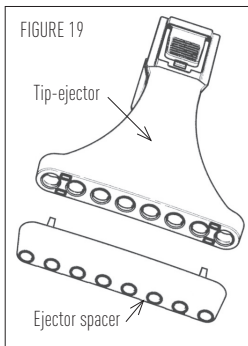

# BIOTIX COBRA PIPETTE

- 2 Immerse the tip-ejector, and ejector spacer in the cleaning solution or wipe them with a soft cloth or lint-free tissue impregnated with the cleaning solution.
- 3 Rinse the components with distilled water.
- 4 Wipe the entire pipette with a soft cloth or lint-free tissue impregnated with the cleaning solution.
- 5 Wipe it with distilled water.
- 6 Leave the parts to dry by evaporation or wipe them with a clean soft-cloth or lint-free tissue.
- 7 Refit the tip-ejector as described in "Changing the tip-ejector".

## Chemical Decontamination

You may choose to decontaminate your pipette chemically, in accordance with your own procedures. Whatever decontaminant you use, check with the supplier of the decontaminant that it is compatible with stainless steel and the plastics used in the construction of the pipette: PBT (Polybutylene Terephthalate), PC (Polycarbonate), PC/PBT (Polycarbonate/Polybutylene Terephthalate), PEEK (Polyetheretherketone), PEI (Polyetherimide), POM (Polyoxymethylene), PPS (Polyphenylene Sulfide), PVDF (Polyvinylidene Fluoride), or PP (Polypropylene).

### *For the single models:*

#### *Upper Part (handle)*

- 1 Wipe the upper part (handle) of the pipette with a soft cloth or lint-free tissue impregnated with the chosen decontaminant.
- 2 Wipe the upper part of the pipette with a soft cloth or lint-free tissue soaked with distilled water or sterile water.

#### *Lower Part (Volumetric module)*

The following components **only** can be immersed in a decontaminant solution: connecting nut, tip-ejector, tip-holder.

Piston assembly and seals must be degreased with methyl alcohol before being immersed in decontamination solution in separate vessel.

- 1 Disassemble the pipette as described in the chapter 12A.

- 2 Immerse tip-ejector, tip-holder and connecting nut in the cleaning solution.
- 3 Degrease the piston assembly, the seals and immerse them in another vessel.
- 4 Rinse each component with distilled water.
- 5 Leave the parts to dry by evaporation (or wipe with a soft cloth the tip-ejector, the tip-holder and connecting nut).
- 6 Lubricate the piston assembly and the seals.
- 7 Reassemble the piston assembly, the tip-holder and the tip-ejector.

### ***For the multichannel models:***

The following components only can be immersed in a decontamination solution: tip-ejector and ejector spacer.

- 1 Remove the tip-ejector and the ejector spacer.
- 2 Immerse the tip-ejector and ejector spacer in the decontamination solution or wipe them with a soft cloth or lint-free tissue impregnated with the decontamination solution.
- 3 Rinse the components with distilled water.
- 4 Wipe the entire pipette with a soft cloth or lint-free tissue impregnated with the decontamination solution.
- 5 Wipe it with distilled water.
- 6 Leave the parts to dry by evaporation or wipe them with a clean soft-cloth or lint-free tissue.
- 7 Refit the tip-ejector as described in "Changing the tip-ejector".

### **Sterilization**

The entire autoclavable range of pipettes can be sterilized by steam autoclaving at 121°C (252°F), 1 atm for 20 minutes. The single and multichannel pipettes can be autoclaved without special precautions. Use of a bag is not recommended in order to improve the drying of the pipette.

**After autoclaving, check the connecting nut is fully tightened and screw it if it is not the case.** The pipette needs to dry completely and cool down to room temperature. (1/2 day if your autoclave has a dry cycle or otherwise overnight before use). The piston does not need to be lubricated after autoclaving, except if grease

# BIOTIX COBRA PIPETTE

was removed during cleaning. Gravimetric checking is recommended after every 5 autoclave cycles for single pipettes and after 1 cycle for multichannel pipettes.

## 14 - SPECIFICATIONS

Biotix Cobra pipettes are high quality. These pipettes are compatible with Biotix tips for optimum results of the pipetting system. It guarantees you precise and accurate results. However, checking and recalibrating your pipette with the tips that you use may be needed.

Each pipette is inspected and validated by qualified technicians in accordance with the Biotix Quality System. Biotix declares that its manufactured pipettes comply with the requirements of the ISO8655 standard, by type testing.

The adjustment is carried out under strictly defined and monitored conditions (described in the internal manufacturer procedure which are based on the ISO8655).

### Single models

Model	Volume range ( $\mu\text{L}$ )	Volume ( $\mu\text{L}$ )	SPECIFICATIONS - Error limits			
			Systematic error ( $\mu\text{L}$ )	Systematic error (%)	Random error ( $\mu\text{L}$ )	Random error (%)
BTX-2	0.2 - 2	0.2	$\pm 0.026$	$\pm 13.2$	$\leq 0.013$	$\leq 6.6$
		2	$\pm 0.033$	$\pm 1.7$	$\leq 0.015$	$\leq 0.8$
BTX-10	1 - 10	1	$\pm 0.035$	$\pm 2.8$	$\leq 0.013$	$\leq 1.3$
		10	$\pm 0.110$	$\pm 1.1$	$\leq 0.044$	$\leq 0.4$
BTX-20	2 - 20	2	$\pm 0.11$	$\pm 5.5$	$\leq 0.033$	$\leq 1.7$
		20	$\pm 0.20$	$\pm 1.0$	$\leq 0.066$	$\leq 0.3$
BTX-100	10 - 100	10	$\pm 0.39$	$\pm 3.9$	$\leq 0.11$	$\leq 1.1$
		100	$\pm 0.80$	$\pm 0.8$	$\leq 0.17$	$\leq 0.2$
BTX-200	20 - 200	20	$\pm 0.55$	$\pm 2.8$	$\leq 0.22$	$\leq 1.1$
		200	$\pm 1.60$	$\pm 0.8$	$\leq 0.33$	$\leq 0.2$
BTX-1000	100 - 1 000	100	$\pm 3.3$	$\pm 3.3$	$\leq 0.7$	$\leq 0.7$
		1000	$\pm 8.0$	$\pm 0.8$	$\leq 1.7$	$\leq 0.2$
BTX-5000	500 - 5 000	500	$\pm 13$	$\pm 2.6$	$\leq 3.3$	$\leq 0.7$
		5000	$\pm 33$	$\pm 0.7$	$\leq 8.8$	$\leq 0.2$
BTX-10mL	1000 - 10000	1000	$\pm 33$	$\pm 3.3$	$\leq 6.6$	$\leq 0.7$
		10000	$\pm 60$	$\pm 0.6$	$\leq 17.6$	$\leq 0.2$



The data given in the tables are achieved with Biotix standard length series pipette tips. If you are using Biotix 10 µL extended length series pipette tips, you will need to recalibrate your pipette to comply with specifications.

### Multichannel models

Model	Volume range (µL)	Volume (µL)	SPECIFICATIONS - Error limits			
			Systematic error (µL) (%)		Random error (µL) (%)	
BTX-8X-10	0.5-10	0.5	± 0.09	± 17.6	≤ 0.04	≤ 8.8
BTX-12X-10		10	± 0.22	± 2.2	≤ 0.11	≤ 1.1
BTX-8X-20	2-20	2	± 0.11	± 5.5	≤ 0.09	≤ 4.4
BTX-12X-20		20	± 0.40	± 2.0	≤ 0.17	≤ 0.8
BTX-8X-200	20-200	20	± 0.6	± 2.8	≤ 0.28	≤ 1.4
BTX-12X-200		200	± 2.2	± 1.1	≤ 0.55	≤ 0.3
BTX-8X-300	20-300	20	± 1.1	± 3.7	≤ 0.39	≤ 1.3
BTX-12X-300		300	± 3.3	± 1.1	≤ 1.10	≤ 0.4



**The data given in the tables conform to the ISO8655-2 Standard. With a precise pipetting technique (see Chapter 7 - General guidelines for good pipetting) the BTX-2 model may be used to aspirate volumes as low as 0.1 µL and the BTX-10 model as low as 0.5 µL.**

## 15A - SPARE PARTS FOR SINGLE MODELS

### BTX-2 and BTX-10

	Description	Quantity	BTX-2	BTX-10
<b>A</b>	Push button	5	FE07004	FE07005
<b>B</b>	Connecting nut	5	FE07002	FE07002
<b>C</b>	Piston assembly	1	FE07040	FE07041
<b>D</b>	Seal + O-ring	5	FE07050	FE07051
<b>E</b>	Tip holder	5	FE07014	FE07016
<b>F1 F2</b>	Tip-ejector assembly + ejector adaptor	5	FE07029	FE07029

# BIOTIX COBRA PIPETTE

FIGURE 20

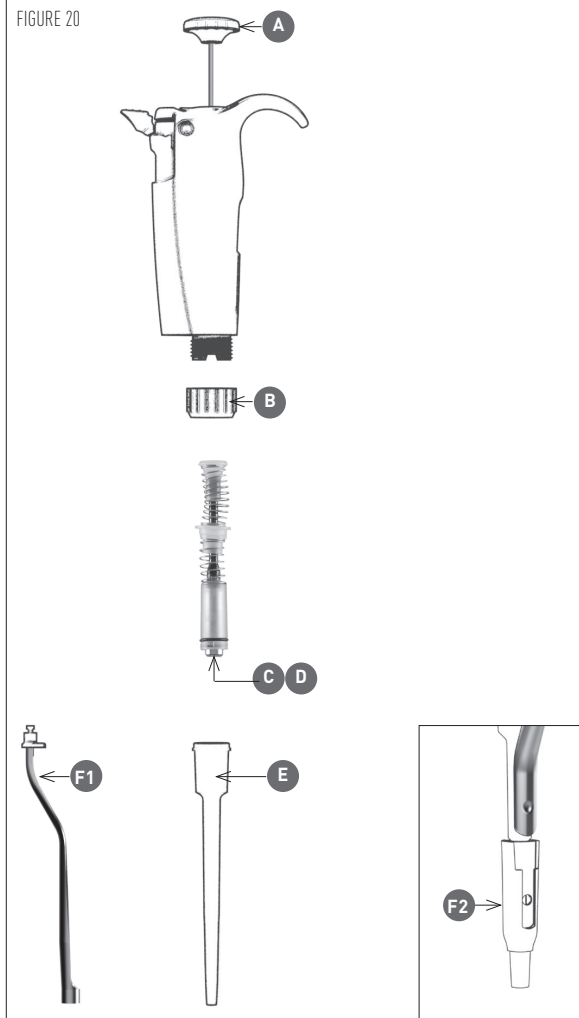

## BTX-20 and BTX-100

	Description	Quantity	BTX-20	BTX-100
<b>A</b>	Push button	5	FE07006	FE07007
<b>B</b>	Connecting nut	5	FE07002	FE07002
<b>C</b>	Piston assembly	1	FE07042	FE07043
<b>D</b>	Seal + O-ring	5	FE07052	FE07053
<b>E</b>	Tip holder	5	FE07018	FE07020
<b>F1</b>	Tip-ejector assembly	5	FE07030	FE07031

## BTX-200 and BTX-1000

	Description	Quantity	BTX-200	BTX-1000
<b>A</b>	Push button	5	FE07008	FE07009
<b>B</b>	Connecting nut	5	FE07002	FE07002
<b>C</b>	Piston assembly	1	FE07044	FE07045
<b>D</b>	Seal + O-ring	5	FE07054	FE07055
<b>E</b>	Tip holder	5	FE07022	FE07024
<b>F1</b>	Tip-ejector assembly	5	FE07032	FE07033

## BTX-5000 and BTX-10mL

	Description	Quantity	BTX-5000	BTX-10mL
<b>A</b>	Push button	5	FE07010	FE07011
<b>C</b>	Piston assembly	1	FE07047	FE07049
<b>D</b>	Seal + O-ring	5	FE07056	FE07057
<b>E</b>	Tip holder	5	FE07026	FE07028
	Filter for 5000 $\mu$ L / 10 mL*	10	FE07058	FE07058

\* Not shown.

# BIOTIX COBRA PIPETTE

## 15B - SPARE PARTS FOR MULTICHANNEL MODELS

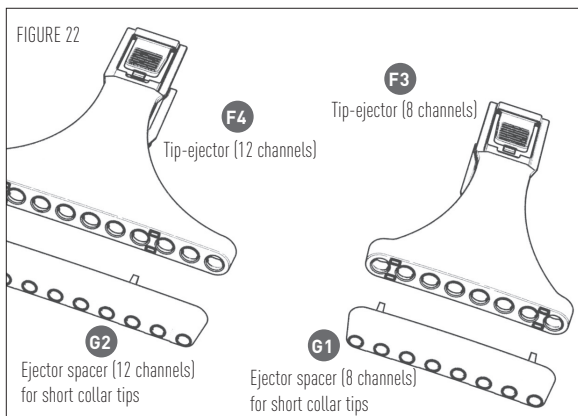

### BTX-8X-10 and BTX-12X-10

Description	Quantity	BTX-8X-10	BTX-12X-10
<b>A</b> Push button	5	FE07005	FE07005
<b>F3 F4</b> Spacer	1	FE07036	FE07037
<b>G1 G2</b> Ejector	1	FE07038	FE07039

### BTX-8X-20 and BTX-12X-20

Description	Quantity	BTX-8X-20	BTX-12X-20
<b>A</b> Push button	5	FE07006	FE07006
<b>F3 F4</b> Spacer	1	FE07036	FE07037
<b>G1 G2</b> Ejector	1	FE07038	FE07039

### BTX-8X-200 and BTX-12X-200

Description	Quantity	BTX-8X-200	BTX-12X-200
<b>A</b> Push button	5	FE07008	FE07008
<b>F3 F4</b> Spacer	1	FE07036	FE07037
<b>G1 G2</b> Ejector	1	FE07038	FE07039

## BTX-8X-300 and BTX-12X-300

Description		Quantity	BTX-8X-300	BTX-12X-300
<b>A</b>	Push button	5	FE07012	FE07012
<b>F3</b> <b>F4</b>	Spacer	1	FE07036	FE07037
<b>G1</b> <b>G2</b>	Ejector	1	FE07038	FE07039

# BIOTIX COBRA PIPETTE

## MAINTENANCE & CALIBRATION

Biotix recommends pipette calibration and maintenance at least once annually by the authorized service provider, Gilson. Please contact Gilson directly at 800-445-7661 or [service@pipetman.com](mailto:service@pipetman.com) regarding mail-in and onsite service options or visit their website at [www.gilson.com](http://www.gilson.com) to learn more.

## WARRANTY

Biotix warrants this pipette against defects in material under normal use and service for a period of 12 months from the date of purchase. An extended warranty is possible on request. It extends the standard warranty coverage for a maximum of 2 years on selected components.

This warranty shall not apply to pipettes which are subject to abnormal use, and/or improper or inadequate maintenance (contrary to the recommendations given in the User's guide), including, but not limited to pipettes which have been subjected to physical damage, improper handling, spillage or exposure to any corrosive environment. This warranty shall also be void in the event pipettes are altered or modified by any party other than Biotix. The company's sole liability under this warranty shall be limited to repair or replace any defective components of pipettes or refund of the purchase price paid for such pipettes.

**THE FOREGOING WARRANTY IS EXCLUSIVE AND BIOTIX HEREBY DISCLAIMS ALL OTHER WARRANTIES, WHETHER EXPRESS OR IMPLIED, INCLUDING ANY WARRANTIES OF MERCHANTABILITY AND ANY WARRANTIES OF FITNESS FOR A PARTICULAR PURPOSE, UNDER NO CIRCUMSTANCES SHALL BIOTIX BE LIABLE FOR ANY CONSEQUENTIAL, PUNITIVE, INDIRECT OR INCIDENTAL DAMAGES ARISING OUT OF ANY BREACH OF ANY EXPRESS OR IMPLIED WARRANTY.**

LT801552/A - ©2015 Biotix All rights reserved  
English

Specifications subject to change without notifications - errors omitted.

March 2015  
Printed in France

**BIOTIX**

9880 Mesa Rim Road - San Diego, CA 92121 - USA

Email Customer Service: [CSR@biotix.com](mailto:CSR@biotix.com)

Phone: Domestic 888.330.2396 International +1 858.875.7696

Fax: +1 858.875.5496

